

Operating manual

Progressive Block Distributor PVB

BA_2017_1_GB_PVB

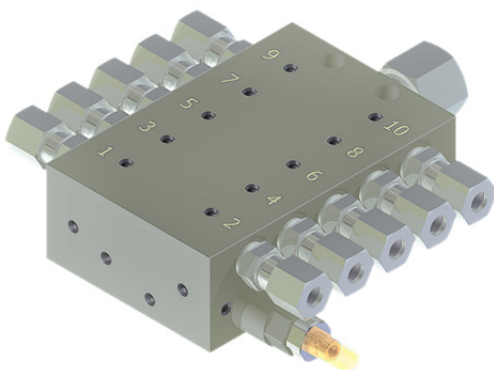

INDEX

1. General	2
2. Safety	2 - 3
3. Application and General Features of Product	4
4. Design and Function	4 - 6
5. Technical Data	7 - 8
6. Distributor Configuration and Coding	9
7. Examples of Order	10
8. Notes on Distributor Design	10 - 11
9. Accessories	12 - 13
10. Assembly, Installation and Commissioning	13 - 14
11. Maintenance and Servicing	15
12. Spare Parts	16
13. Storage and Transport	16
14. Suitable System Components	16

1. GENERAL

Prior to start up, we recommend to read these operating instructions carefully as we do not assume any liability for damages and operating troubles which result from the nonobservance of these operating instructions!

The below described divider is designed for use in centralized lubrication systems to distribute the supplied lubricant. Any use beyond the applications described in these operating instructions is considered to be not in accordance with the product's intended purposes. The manufacturer is not to be held responsible for any damages resulting from this: the user alone bears the corresponding risk.

As to figures and indications in these operating instructions we reserve the right to make technical changes which might become necessary for improvements.

The copyright on these operating instructions is kept reserved to the company DELIMON. These operating instructions are intended for the erecting, the operating and supervising personnel. They contain regulations and drawings of technical nature which must not - completely or partially - be distributed nor used nor communicated to others without authorization for competition purposes.

Company address, spare parts and service address

DELIMON GmbH
Arminstraße 15
D-40277 Düsseldorf
Phone +49 211 7774-0
Fax +49 211 7774-210

Branch office
Am Bockwald 4
D-08344 Grünhain-Beierfeld
Email: kontakt@bijurdelimon.com
www.bijurdelimon.com

2. SAFETY

These operating instructions contain fundamental instructions which are to be observed during erection, operation and maintenance. Therefore it is absolutely necessary for the fitter and the competent qualified staff/user to read these operating instructions before installation and start-up. The operating instructions must be available at all times at the place of use of the machine/system.

Not only the general safety instructions stated under this main point "safety" are to be observed, but also the other specific safety instructions stated under the other main points.

2.1 Identification of safety warnings in the operating instructions

The safety warnings contained in these operating instructions which, if not observed, may cause dangers to people, are specially marked with general danger symbols



safety sign according to DIN 4844, warning about a danger spot, in case of warning about electric voltage with



safety sign according to DIN 4844, warning about dangerous electric voltage.

In case of safety instructions which, if not observed, may cause damage to the product and its function, the word

ATTENTION

is inserted.

Instructions that are directly attached to the machine, as for example

- rotational direction arrow
- identifications for fluid connections must be observed at all events and maintained in a fully legible condition.
- Note: There is an increased skid risk in case of spilled/leaked out lubricants. They are to be removed at once properly.



Safety sign according to DIN 4844, warning about skid risk.

2. SAFETY

2.2 Personnel qualification and training

The operating, maintaining, inspecting and erecting personnel must have the appropriate qualification for such work. Area of responsibility, competence and supervision of the personnel have to be regulated by the user. If the personnel do not have the necessary knowledge, they have to be trained and given instructions. This can be effected, if necessary, by the manufacturer/supplier on behalf of the user of the machine. Furthermore, the user has to make sure that the contents of the operating instructions are fully understood by the personnel.

2.3 Dangers in case of nonobservance of the safety instructions

The nonobservance of the safety instructions may result in hazards to persons, to the environment and to the product. The non-observance of the safety instructions may lead to the loss of any claims for damages.

In detail, the nonobservance may for instance lead to the following hazards:

- Failure of important functions of the product/system/machine
- Failure of prescribed methods for maintenance and repair
- Hazard to persons by electrical, mechanical and chemical influences
- Hazard to the environment by the leakage of dangerous substances

2.4 Safety conscious working

The safety instructions stated in these operating instructions, the existing national regulations as to the accident prevention as well as possible internal working, operating and safety rules of the user are to be observed.

2.5 Safety instructions for the user/operator

- If hot or cold product or machine parts lead to dangers, these parts have to be protected against touch.
- Protection against touch for moving parts (e. g. coupling) must not be removed when the machine is in operation.
- Leakages (e. g. from the shaft seal) of hazardous goods to be delivered (e. g. explosive, toxic, hot) are to be removed in such a way that there is no danger to persons and environment. Legal rules are to be observed.

- Hazards caused by electrical power are to be excluded (for details please refer for instance to the rules of the VDE and the local power supply companies).

2.6 Safety instructions for maintenance, inspection and installation work

The user has to take care that all the maintenance, inspection and installation work is executed by authorized and qualified skilled personnel who have informed themselves adequately by thoroughly studying the operating instructions. Basically, work on the machine is only to be carried out during shut-down. It is obligatory to observe the shut-down procedure described in the operating instructions.

Pumps or pump aggregates that deliver media being hazardous to health have to be decontaminated. Immediately after completion of the work, all safety and protective equipments have to be reinstalled and/or reactivated.

- Advice: When working with compressed air, do wear glasses.



(DIN 4844 – Use breathing mask)

- Advice: Observe EC-Safety Data Sheet for materials of consumption and additives used and use personal protective equipment.

Before recommissioning, observe the points stated in section "10".

2.7 Unauthorized conversion and manufacture of spare parts

Conversion or modifications to the product are only permitted when agreed with the manufacturer. Original spare parts and accessories authorized by the manufacturer serve to ensure safety. The use of other parts may render the liability for consequential losses null and void.

2.8 Unacceptable modes of operation

The operational reliability of the product supplied is only guaranteed if the product is used in accordance with its intended purposes as per section 1 - General - of the operating instructions. The limiting values specified in the data sheet must on no account be exceeded.

2.9 Guidelines & standards

1., 2. and 3. guideline (see data sheet: R&N_2009_X_GB)

2.10 Notes on environmental protection and waste disposal

In correct operation with lubricants, the components are subject to the special requirements set by environmental legislation.

The general requirements for lubricants are specified in the respective safety data sheets.

Used lubricants are hazardous forms of waste and therefore require special supervision in the sense of § 41 paragraph 1 sentence 1 and paragraph 3 no. 1 of KrW-/AbfG (Closed-Loop Waste Management Act).

Used oils must be handled in compliance with AltöIV (Waste Oil Ordinance).

The devices or components contaminated with lubricant must be disposed of by a certified waste management company. Records of proper waste management must be filed in conformance to NachwV (Ordinance on Waste Recovery and Disposal Records).

3. APPLICATION AND GENERAL FEATURES OF PRODUCT

- Progressive distributor
- Compact block design
- Medium: grease and oil
- Operating pressure up to 350 bar
- up to 20 outlets for Ø 6 mm pipe
- Metered volume 0.20 cm³
- Material: steel with corrosion-resistant zinc-nickel coating as per DIN 50970 or stainless steel 1.4305/1.4404
- Visual or electric monitoring possible
- engraved distributor coding for permanent traceability

The PVB – distributors are mainly used in progressive systems using standardised metered quantities and offer a cost-effective and rational solution for the central supply of lubrication points. In addition, the high operating pressure up to 350 bar provides the function of sub-distributors in large two-line systems.

4. DESIGN AND FUNCTION

PVB distributors are piston distributors which evenly distribute the supplied lubricant. This is achieved by means of metal sealing pistons which dispense the lubricant to the connected lubrication points progressively (one after another). Due to the way the pistons work under pressure in the PVB distributor, it is possible to monitor the functioning of the system (either visually or electronically) with little effort. The distributor dispenses for as long as it is supplied with lubricant at a sufficient pressure. Once an individual metered volume (0.20 cm³) of lubricant is dispensed from each outlet in turn this is called a distributor cycle. The lubricant required is controlled via the number of cycles / time units.

Cross section view of a PVB distributor

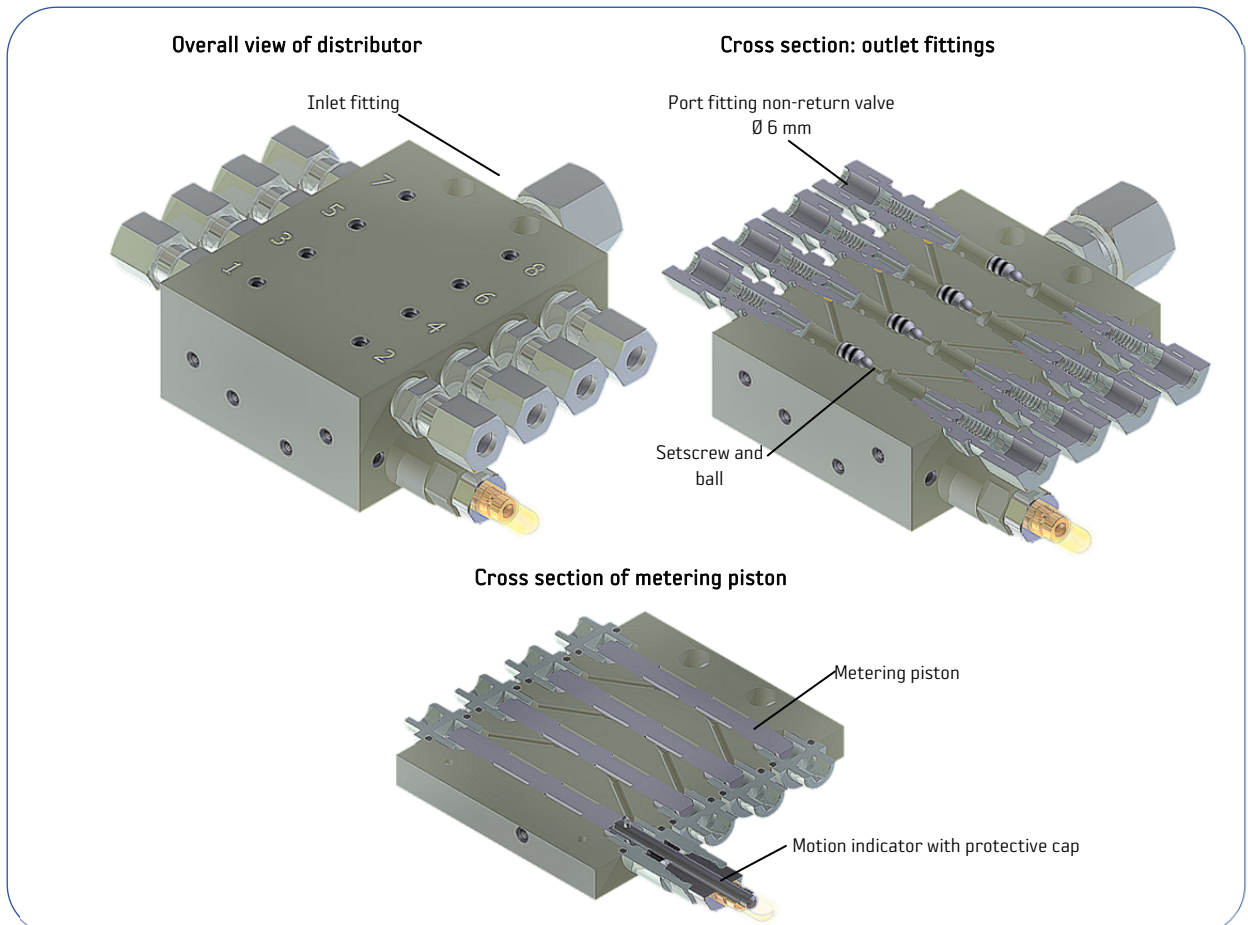

4. DESIGN AND FUNCTION

The PVB distributor is available in 8 different sizes (or 6 for the stainless steel version), depending of the number of outlets required. The minimum configuration contains 3 pistons providing up to 6 outlets. Each additional size has an additional metering piston and an additional pair of outlets.

Dimensions (mm):

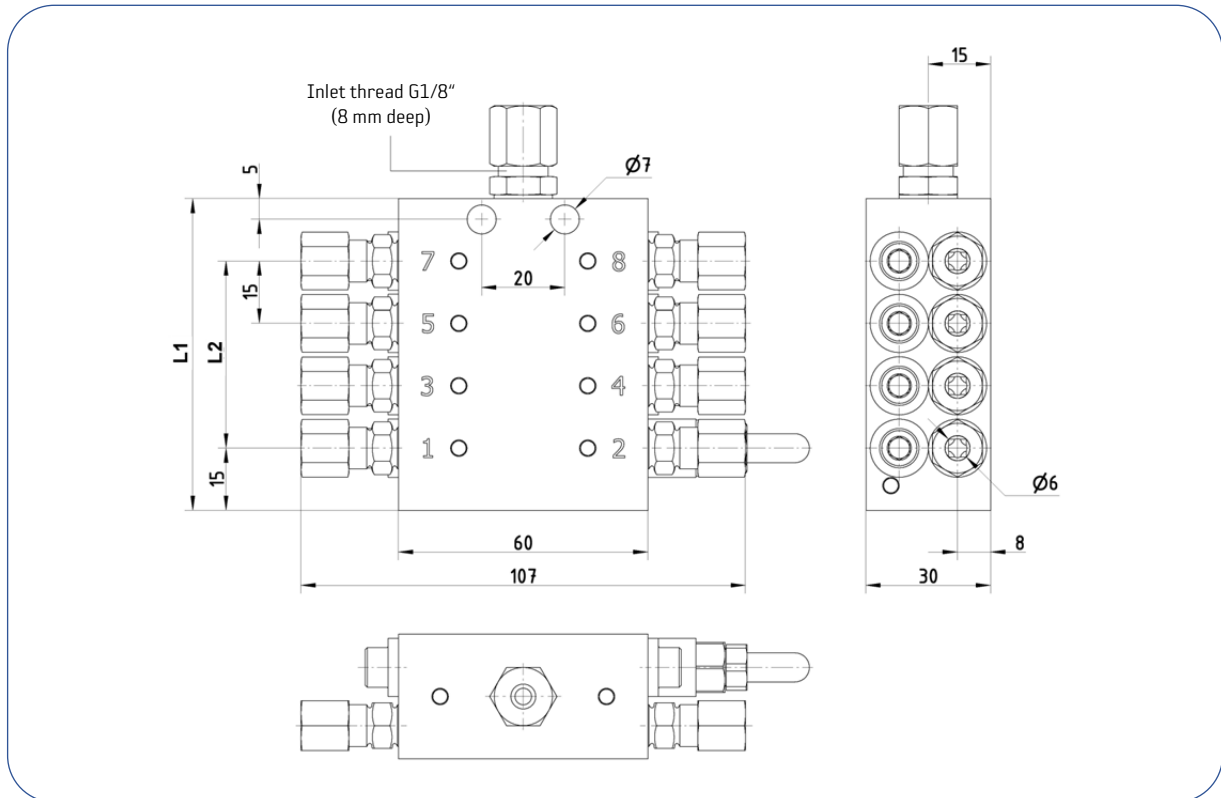

NUMBER OF OUTLETS	up to 6	up to 8	up to 10	up to 12	up to 14	up to 16	up to 18	up to 20
L1 [MM]	60	75	90	105	120	135	150	165
L2 [MM]	30	45	60	75	90	105	120	135
WEIGHT [KG]	0.9	1.1	1.3	1.5	1.7	1.9	2.1	2.3

Note: Stainless steel version has max. 16 outlets

Closing outlets

Within the distributor block it is possible to connect adjacent outlets or outlets that are opposite each other, in order to achieve a higher metered volume for individual outlets, for example.

WARNING

Special fittings with non-return valves (similar to DIN 2353 - CLL 6 - St fittings) are used to connect the lubrication lines for 6 mm diameter pipes; these also take on a sealing function inside the distributor. These fittings **cannot** be replaced by regular cutting ring fittings. The non-return valves that are incorporated into the outlet fittings ensure that the distributor works in a reliable way even with small quantities of lubricant and high counter pressure in lines made of flexible material.

The flow of lubricant inside the distributor must be guaranteed; otherwise the distributor will become blocked. The following illustration shows the two alternatives for connecting and locking distributor outlets.

4. DESIGN AND FUNCTION

Connecting outlets:

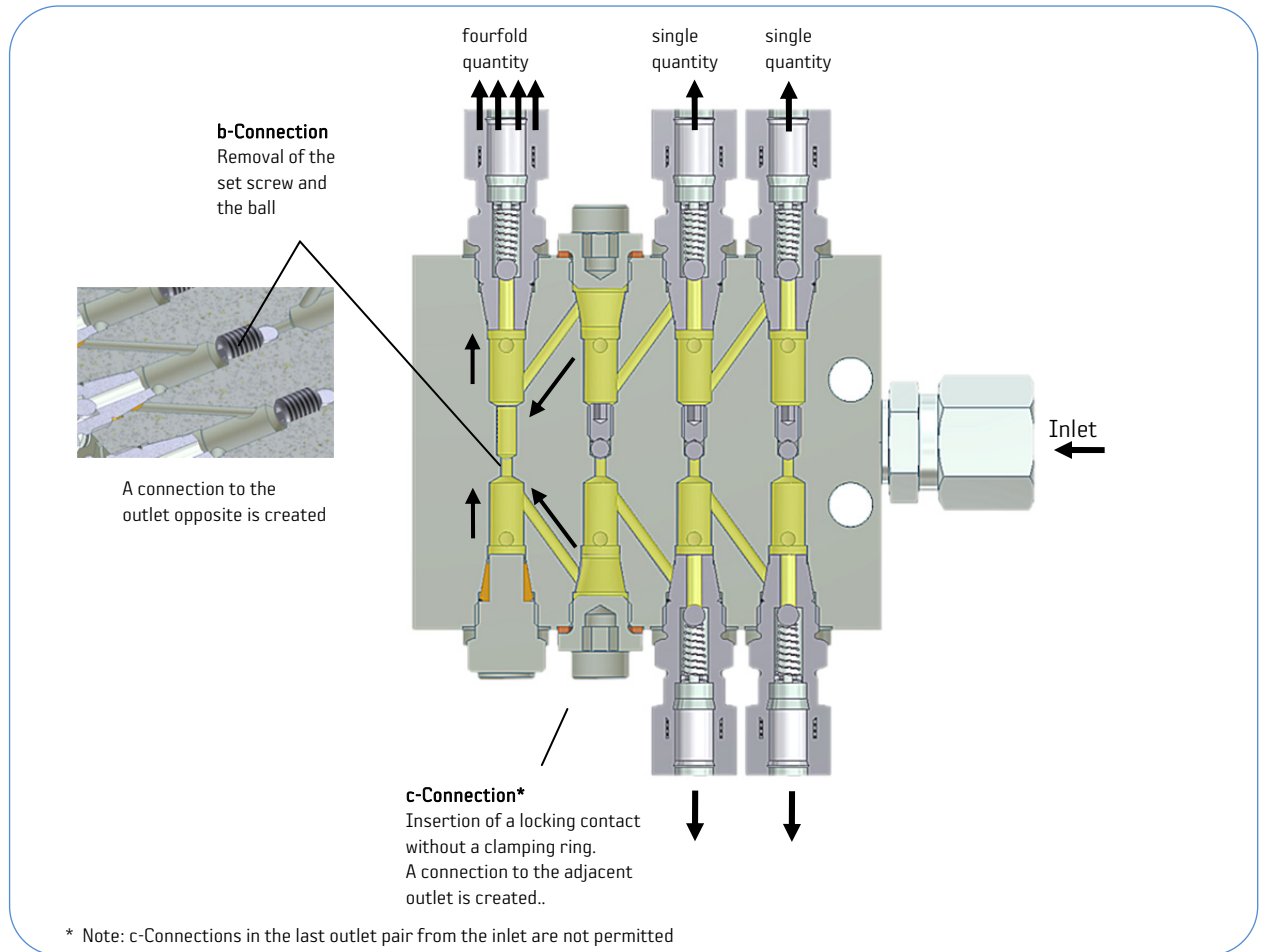

The material required for subsequent modification of the outlets is listed in Chapter 9 "Accessories".

Monitoring

The PVB distributor can be fitted with a motion indicator on the last outlet pair for visually monitoring the piston movement. During one distributor cycle the motion indicator moves out and in once or the reverse, depending on the piston position. In addition the motion indicator can be read electrically using a proximity switch. In this case it must be ensured that the same side is always evaluated using the control mechanism.

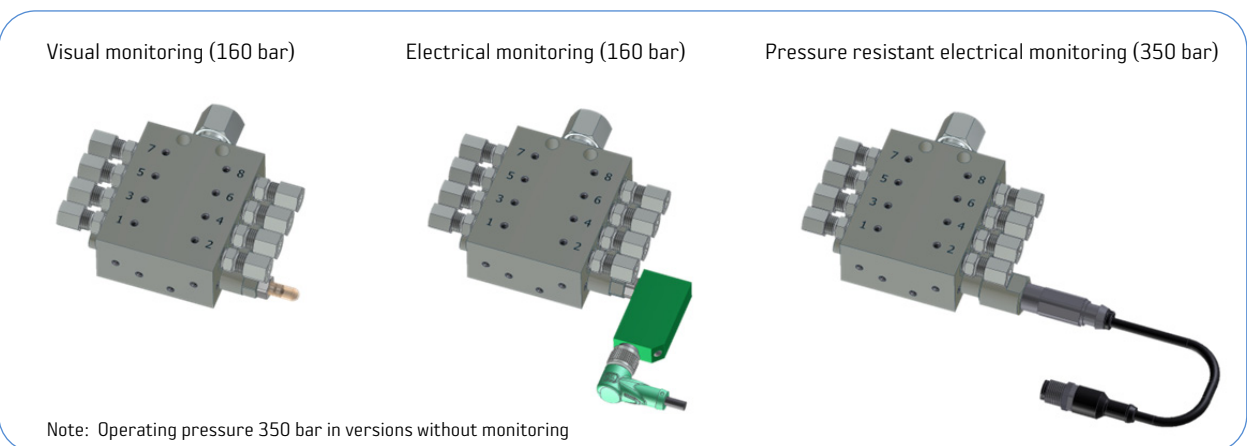

5. TECHNICAL DATA

PVB distributor

Max. operating pressure:	
in versions with motion indicator	160 bar
in pressure resistant versions (without motion indicator)	350 bar
Metered volume per piston stroke per outlet	0.20 cm ³
Opening pressure	10 bar
Temperature range (without electrical monitoring)	-20 to +120°C
Permitted volume flow (for oil)	0.5 to 1000 cm ³ /min
Permitted differential pressure between the outlets	100 bar
maximum permitted operating pressure when using non-return valves	

Suitable lubricants based on mineral oil:

Grease	NLGI class 000 to 2 DIN 51818
Oil	ISO VG 68 to 1500 operating viscosity DIN 51519
Synthetic lubricants	on request

The NLGI-class as per DIN 51818 indicates the consistency of the lubricant, and gives information on the stiffness of the grease.

It does not give any indication of the general ability to supply in lubrication systems, since lubricating greases with the same NLGI class can have different flow characteristics.

On an individual basis we will be happy to test your lubricant in our facilities for ability to supply.

Connectable pipelines:

Inlet (Port thread: G 1/8)	Ø 6/8/10 mm
Outlet (M 10x1, Special fitting)	Ø 6 mm

Measurement and weight see table on page 5

5. TECHNICAL DATA

Electrical monitoring 66925-1311 (Standard version 160 bar)

Type of protection :	IP 65
Operating voltage :	10 to 30V DC
Output current :	max. 200 mA
Switching function :	N/O contact
Switching frequency :	max. 1000 Hz
Temperature range :	-25 to +70°C
Supply line protected against polarity reversal :	yes
Supply line short-circuit protection :	no

Circuit diagram and dimensions:

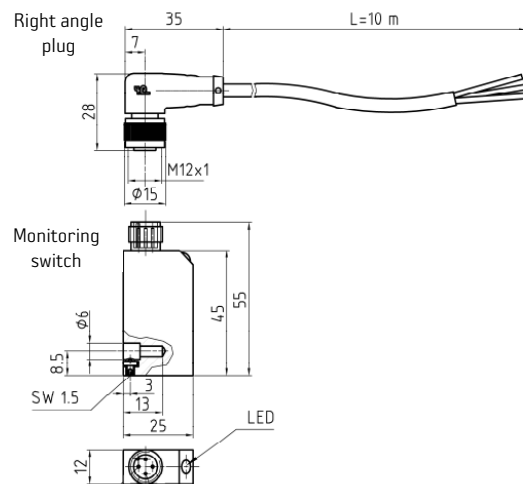
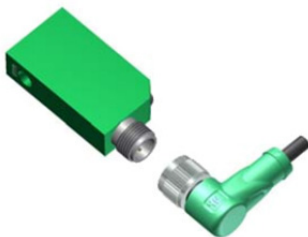
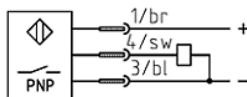

Electrical monitoring 76925N018 (pressure-resistant version 350 bar)

Type of protection :	IP 67
Operating voltage :	10 to 60V DC
Output current :	max. 100 mA
Switching function :	N/O contact
Switching frequency :	max. 100 Hz
Temperature range :	-25 to +70°C
Short-circuit protection :	clocked
Connection :	PUR-cable / 0.3 m with M12 plug-in connector
Housing material :	PEEK (polyether-ether ketone) / V4A (1.4571)

Circuit diagram and dimensions:

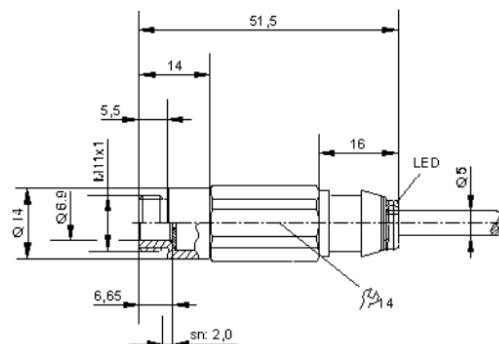
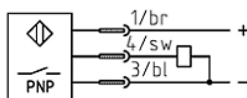

6. DISTRIBUTOR CONFIGURATION AND CODING

Code example: PVB 08 A 02 A A F B [] [] [] [] [] [] 02

Outlet pairs: 7+8 5+6 3+4 1+2 Optional for further outlet pairs

Number of outlets (steel):

- up to 6 outlets - 06
- up to 8 outlets - 08
- up to 10 outlets - 10
- up to 12 outlets - 12
- up to 14 outlets - 14
- up to 16 outlets - 16
- up to 18 outlets - 18
- up to 20 outlets - 20

Revision A (no alternative)

Number of outlets (stainless steel):

	1.4305	1.4404
up to 6 outlets	- E6	- F6
up to 8 outlets	- E8	- F8
up to 10 outlets	- EA	- FA
up to 12 outlets	- EC	- FC
up to 14 outlets	- EE	- FE
up to 16 outlets	- EF	- FF

Monitoring:

- without motion indicator (350 bar) - 01
- with motion indicator (160 bar) - 02
- with motion indicator and monitoring switch (160 bar) - 03
- with motion indicator and pressure-resistant monitoring switch (350 bar) - 08

Outlet codes:

- A - both outlets open (AA)
- B - left outlet open, right closed (AB)
b-connection open
- C - right outlet open, left closed (BA)
b- connection open
- D* - left outlet open, right closed (AC)
c-right connection open
- E* - right outlet open, left closed (CA)
c-left connection open
- F* - both outlets closed (CC)
c-connections open on both sides
- G* - both outlets closed (BC)
b-connection and c-right connection open
- H* - both outlets closed (CB)
b-connection and c-left connection open

Note:

Each letter describes a pair of outlets. It starts with the outlet pair at the inlet with the highest number.

The number of letters used for the outlet codes depends on the size of the distributor. The minimum configuration with 6 outlets requires at least 3 letters. In this example there are 4 pairs of outlets, so 4 letters must be defined - according to the above table.

* The codes D, E, F, G, H (c-connection) are not permitted in the last outlet pair (1+2) for functional-technical reasons.

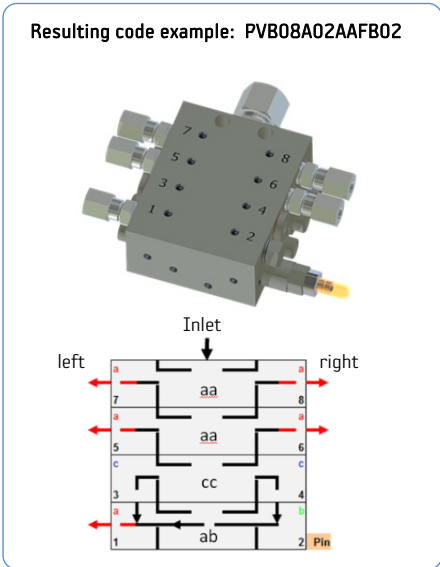

Accessories (for pre-assembled delivery):

Without inlet fitting, only outlet fittings	00
Inlet fitting for Ø.6 mm pipe and outlet fittings	01
Inlet fitting for Ø 10 mm pipe and outlet fittings	02
No fittings (Special fittings must be selected from the Accessories Table page 12/13)	03

7. EXAMPLES OF ORDER

By combining two outlets the metered quantity is doubled. If an outlet is closed, in order to obtain an odd number of outlets, this leads to a metered quantity ratio of 2:1 at one outlet. If equal metered quantities are required, all the outlets must be coded as combined outlet pairs. The following examples show frequently used configurations for 2 - 6 outlets:

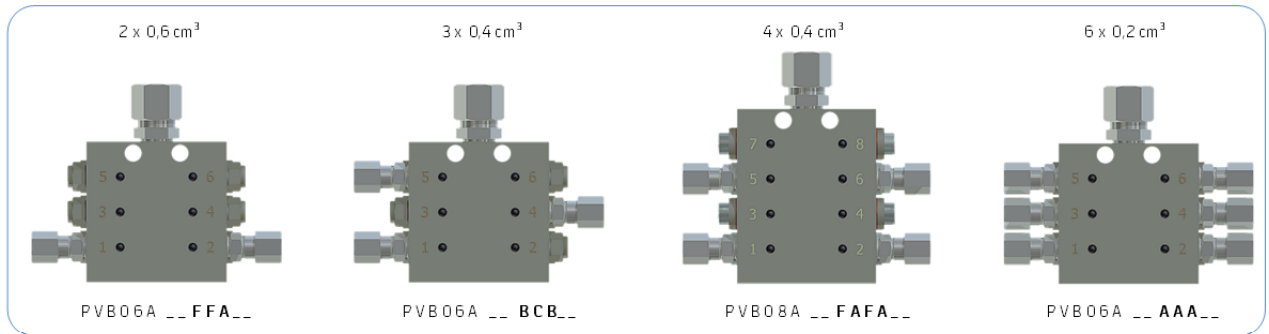

8. NOTES ON DISTRIBUTOR DESIGN

Quantity ratios

The basis of the distributor design is the number of all lubricant points to be supplied with the required lubricant/time unit. From this the available **quantity ratios** are calculated. The aim is to achieve the desired quantity of lubricant in "X" number of distributor cycles. The specified metered quantity/ cycle is not relevant for the supply to the lubrication points. It does not make any difference in practice whether a distributor dispenses e.g. 3 x 0.4 or 3 x 0.8 cm³ on the lubrication points per cycle. The crucial factor is only the pumping capacity and its distribution over the PVB distributor, as the following example shows.

Pumping capacity: 12 cm³/min
 Distributor configuration 1: 3 x 0.4 cm³
 Distributor configuration 2: 3 x 0.8 cm³

In both cases the 3 lubrication points each receive 4 cm³/min, since the distributors divide the lubricant into three equal quantities.

Distributor 1 thus clocks 10 cycles/min, distributor 2 needs only 5 cycles/min due to the higher metered quantity and simply runs more slowly. Thus only the cycle frequency of the distributor changes.

Monitoring (can be selected as an option)

In a closed progressive system it is recommended to monitor the distributors, in order to allow you to observe and control how the system is working. **Electrical monitoring** can be used not only for monitoring the function of the system, but also as an indicator for the automatic control of the system. The required supply quantity is programmed, with breaks and monitoring time, via the number of distributor cycles.

Which distributors are monitored in the progressive system?

If a progressive system consists of main and sub-distributors, only the main distributors are monitored electrically as a rule. Visual monitoring is sufficient for the sub-distributors. The following illustration shows a typical system design with PVB main and sub-distributors.

8. NOTES ON DISTRIBUTOR DESIGN

Example: Progressive system with main and sub-distributors

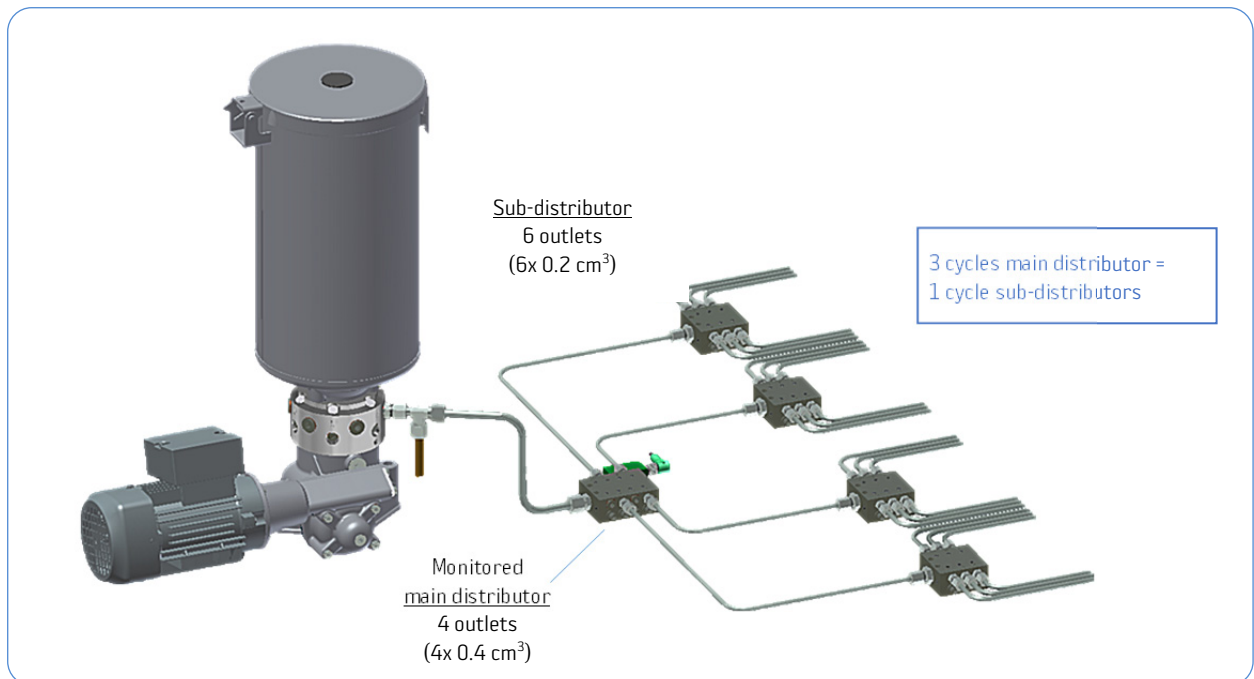

In the above example four equal sub-distributors are connected to a main distributor. The main distributor divides the quantity supplied by the pump into four equal parts. The lubrication points thus all receive the same quantity.

Each sub-distributor needs 1.2 cm³ (6x 0.2 cm³) for one cycle. The main distributor feeds in 0.4 cm³ per cycle, i.e. after three cycles each sub-distributor receives the required quantity to dispense 0.2 cm³ to each lubrication point connected to it. If each lubrication point needs e.g. 1 cm³/day, then 15 cycles of the main distributor are required per day. It is generally preferable to divide the lubrication quantity over several intervals (e.g. 2x per hour).

Further details on the mode of operation and control of progressive systems can be found in the general description of the system. **We are happy to take on the design of complete systems for you – please contact our expert technical advisors directly.**

Pressure resistant version 350 bar (can be selected as an option)

The pressure resistant version is only needed if a supply pressure of over 160 bar may arise due to factors such as extremely long lines, grease that is difficult to convey or low ambient temperature. In most applications 160 bar are sufficient. We can calculate the system pressure for you with the help of our comprehensive rheometer database. If necessary we can offer you tests specially for your type of grease.

9. ACCESSORIES



Inlet fittings

	DESCRIPTION	ORDER NO.	MATERIAL
	GE-fitting GE 06 LR CF *	734421214	A3C
	GE-fitting GE 08 LR1/8 CF	734420853	A3C
	GE-fitting GE 10 LR1/8 CF **	734421633	A3C
	GE-fitting GE 06 LR 71	734461214	1.4571
	GE-fitting GE 08 LR1/8 71	73446V078	1.4571
	GE-fitting GE 10 LR1/8 71	734460323	1.4571

* Included within accessories coding "01"

** Included within accessories coding "02"

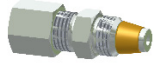
Outlet fittings*

	DESCRIPTION	ORDER NO.	MATERIAL
	Connection fitting with non-return valve 6 mm	734491253	A3C
	Connection fitting with non-return valve 4 mm**	734491263	A3C
	Connection fitting with non-return valve 6 mm,	734490763	1.4571
	Connection fitting with non-return valve for 6mm, plug-in fitting**	73449V010	A3C

* Outlet fittings for 6mm are included within the divider by default. Accessories coding "03" has to order separately if stainless steel of plug-in fittings is required. The number of fittings depends on the number of outlet selection.

** not suitable for 350 bar version

Assembly and fittings

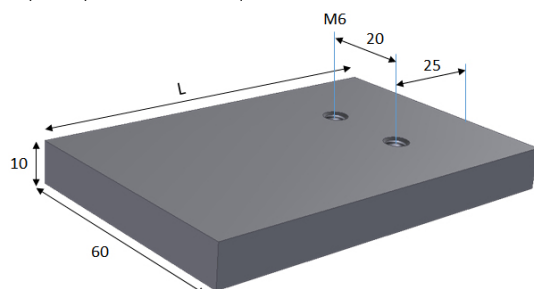

	DESCRIPTION	ORDER NO.	MATERIAL
	Hexagon head screw ISO 4014 - M6x40 - 8.8 - ZNNI5*	741012093	A3C
	Hexagon head screw ISO 4017 - M6x40 - A4 - 70*	74101N101	1.4571
	Disc ISO 7089 - 6 - 200 HV - ZNNI8*	741851064	A3C
	Welt-on plate for installation size up to 6 Auslässe (L=90)	743624311	A3C
	Welt-on plate for installation size up to 8 Auslässe (L=105)	743624321	A3C
	Welt-on plate for installation size up to 10 Auslässe (L=120)	743624331	A3C
	Welt-on plate for installation size up to 12 Auslässe (L=135)	743624341	A3C
	Welt-on plate for installation size up to 14 Auslässe (L=150)	74362P048	A3C
	Welt-on plate for installation size up to 16 Auslässe (L=165)	74362P049	A3C
	Welt-on plate for installation size up to 18 Auslässe (L=180)	74362P050	A3C
	Welt-on plate for installation size up to 20 Auslässe (L=195)	74362P051	A3C

* 2 pieces per each divider required





9. ACCESSORIES

Close / open of outlets

	DESCRIPTION		ORDER NO.	MATERIAL
	Plug screw + clamp ring mounting	} to close b-connection or outlet	741611851	steel ZnNi
	Clamp ring		735113223	brass
	Plug screw M10x1	} to open c-connection	741615741	steel ZnNi
	Sealing DIN 7603 - A 10x13,5		727121094	copper
	Ball	} to close b-connection	719614114	
	Headless pin		741072644	

Accessories for manual lubrication / emergency lubrication

	DESCRIPTION	ORDER NO.	MATERIAL
	High pressure grease nipple, tapered DIN 71452 - A G 1/8" for divider inlet	736831514	A3C
	T-piece 1/8" BSP	73449V066	A3C

Additional accessories like manual grease guns, hoses and fittings you can find within our brochure "Lubrication Assistance".

10. ASSEMBLY, INSTALLATION AND COMMISSIONING

WARNING

Assembly of the PVB distributor may only be carried out by qualified personnel. An appropriate commercially available tool must be used to assemble the pipelines and cutting ring fittings. Please contact our service department if necessary. We can provide service engineers or supervisors for assembly, training and induction - either at a flat rate or invoiced per day.

Installation position and mounting:

The progressive distributor is mounted by means of two mounting holes $\varnothing 7$, preferably with M 6 x 40 hexagonal bolts and washers. The mounting bolts are not normally included in delivery and must be ordered separately if required (see table on page 13).

- The PVB distributor can be fitted in any mounting position without limitations. The side with the engraved outlet numbering should face upwards (to be permanently visible). The pipeline ports are thus on the upper side, which makes it easier to fit the pipes.
- The distributor must be mounted in a stress-free position on a flat surface.
- Weld-on plates (optionally available) must only be welded on without the distributor fitted.

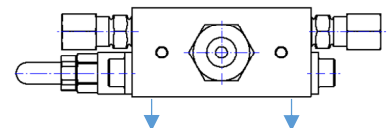

10. ASSEMBLY, INSTALLATION AND COMMISSIONING

Positioning the PVB distributor:

- When installing the distributors it must be ensured that they are positioned as close as possible and in the centre of the connected lubrication points (as far as possible).

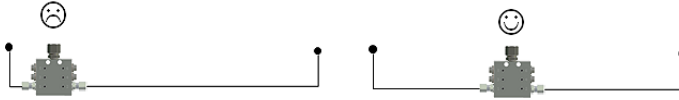

- The PVB distributors must be easily accessible for maintenance and monitoring purposes.

Fitting the pipelines or hoses:

WARNING

- The lubrication lines must be filled with lubricant before fitting.
- Only clean grease or oil may be used!
Particles of dirt can block the distributor and cause the system to fail!
- Cleanliness must be maintained during installation!
- The pipelines must be checked for any contamination (e.g. shavings, etc.) and cleaned if necessary before being filled with lubricant and connected to the distributor.

Commissioning:



- Ensure that the distributor and all the connected pipes are correctly installed before you operate the distributor and lubrication system.
- Ensure that the pump that is connected cannot exceed the permitted operating pressure for the distributor or that it is equipped with a pressure relief valve. Especial care should be taken when using manual lube guns. Most of these can easily produce a pressure of over 500 bar.
- Monitoring the system pressure with a manometer or pressure switch is recommended.
- Once fitted, check the proper operation and impermeability of the system at each installed distributor and lubrication point.

Example of installation:



Continuous operation:

The distributor is designed for continuous operation. Care should be taken during the entire operating phase that the specified operating pressure and temperature range are not exceeded. Only approved lubricant which is free of contamination may be used.

Disassembly:



The distributor must only be disassembled when it is at a standstill and depressurized.

11. MAINTENANCE AND SERVICING

The PVB distributor is basically maintenance-free. Servicing is not required if it is properly operated.

We do not recommend opening/dismantling the distributor. The pistons fit tightly into each cylinder and the smallest amount of contamination can cause a malfunction. Opening the locking contacts and removing the pistons must only be done in clean surroundings by qualified personnel.

WARNING

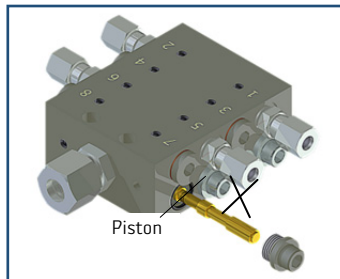

Possible malfunctions and troubleshooting.

Malfunction:

- Leaks
- Distributor not (no longer) running

Possible cause:

- Fittings have not been tightened sufficiently or have become loose due to vibration
- Blockage in one of the attached, lubrication points or lubrication lines
 - Blockage in the downstream sub-distributor
 - Pistons inside the distributor blocked by dirt
 - No lubricant supply due to a pump or control system malfunction
 - No lubricant supply due to a leak or blockage in the supply line

Troubleshooting procedure:

1. Make sure that the pump is supplying lubricant. Remove the inlet fitting on the PVB distributor and let the pump run until lubricant comes out of the open line. If there is no supply of lubricant, check the pump and supply line – otherwise proceed to step 2.
2. Reconnect the inlet fitting (with the system at a standstill) and remove all the outlet lines connected to the PVB distributor. Restart the pump. If no lubricant comes out of the distributor outlets, then there is a blockage inside the distributor. The distributor needs replacing. At the same time the visible grease should be checked for particles of dirt, so that the same problem does not occur again with the new distributor or with other system components. If the distributor runs properly after removing the outlet fittings, proceed to step 3.
3. The cause of the malfunction is not in the distributor itself, but in at least one of the attached lines or lubrication points, or possibly in a sub-distributor. Reconnect the disconnected outlet fittings one by one and carry out a test run after reconnecting each one. This makes it possible to isolate the malfunction and find the affected line.

12. SPARE PARTS

1. Spare Parts Kit: **Seals**

Item no. PVBETA0001

2. Spare Parts Kit: **Motion indicators**

Item no. PVBETA0002

3. Spare Part: **Monitoring switch 10 – 30 V DC**



Item no. 66925-1311

13. STORAGE AND TRANSPORT

The PVB distributor must be transported and stored dry and protected from external agents. The permitted temperature range should also be complied with during storage. Please contact us for clarification if you need to discuss an individual case.

14. SUITABLE SYSTEM COMPONENTS

The following types of pumps are frequently used in conjunction with PVB distributors:

	Pump type	Application:
	FZ-A or FZ-B Pump - three-phase motor - 8, 15, 30 litre container - up to 200 bar - up to 12 outlets	- robust design for harsh industrial environment - for specific requirements for motors, power supply, paintwork, Atex etc. - more than 2 pump outlets needed
	Dynamis Pump - integrated motor (24 V or 230 V) - 2 litre und 4 litre container - connectable to PVB distributor - integrated control system (optional) - up to 300 bar	- space-saving complete solution required with distributor and control system - high operating pressure required - no three phase current supply possible - transparent container preferred
	Dynamis Maxx Pump - integrated motor (24 V or 230 V) - 4, 8, 12, 20 litre container - connectable to PVB distributor - integrated control system (optional) - up to 300 bar	

Other pumps are available for specific applications upon request